



---

## HARBINGER SIGNATURE ACOUSTIC CLICK INSTALLATION GUIDE

---

### BEFORE YOU START

- Signature Acoustic Click planks or tiles are installed without adhesive. Storage should be horizontal, fully supported for a period of 24 hours prior to installation at between 20C and 25C. Stack boxes no more than 3 high during this time.
- Signature Acoustic Click planks or tiles provide a very close fit. Very little force is required to lay the floor. An unprofessional installation can result in damage to the fixing profiles.
- Check Signature Acoustic Click planks or tiles for possible defects prior the installation.
- Material claims can only be accepted prior to installation. Do not install defective material.
- Prior to installation, ensure that the product received is the correct style and colour as well as to the customer's satisfaction. If there are any doubts, do not install the flooring.
- Slight variations in color and structure are designed to enhance natural appearance. Mixing or shuffling the tiles during installation creates a more visually appealing pattern.
- Evaluate rooms for full length windows/patio doors with direct-sustained sunlight in warm climates. Floor exposure to **prolonged direct sunlight and temperature variation** may impact the flooring locking system. Please contact your Harbinger flooring representative for additional information.
- Load limits and high point loads should be considered as not to restrict floor from floating.

### THE SUBFLOOR

- Subfloors must be structurally sound, solid, stable, level, plumb and true to a tolerance in plane of 1/8" in 10 feet (3mm in 4 m) as per NFCA (National Floor Covering Association).
- Cracks and holes must be filled with a cement-based polymer modified patching compound or equivalent.
- Any unevenness over 1/8" (3mm) must be sanded down or levelled. The surface must be clean of dirt, oil, glue residue etc. Carpet staples or adhesive residue should be removed prior to installation. Voids or humps in the subfloor will prevent the planks from locking properly.
- Although these luxury vinyl planks are water-resistant, they are not to be used as a moisture barrier. Your subfloor should be completely dry prior to installation of the vinyl floor.
- The subfloor must be constructed properly – clean, dry, sound and flat. Any bumps caused by paint or plaster drops etc. must be removed.
- Signature Acoustic Click planks or tiles can be installed on existing firm floors (Linoleum, PVC), but all textile floors must be removed. When laying the floor on tiles, fill the gaps with grout or patch to make the surface smooth.
- Signature Acoustic Click planks or tiles are already quiet to walk on. Additional noise reduction is not recommended and will void warranty.

#### Heated Sub Floor

- Radiant heat temperature must not exceed 29.4°C (85°F)
- Do not use radiant heat systems that expose the flooring to wide variations in temperature, such as wire induction mat system.
- Radiant system should be in operation for three weeks prior to flooring installation.
- The installation area of the flooring shall not contain heated and nonheated areas, unless expansion joints separate them. Keep in
- mind that loose rugs or carpets may accidentally function as heat insulators and raise the temperature to more than the tolerated maximum surface temperature of 29.4 °C.(85°F). Area carpet insulates i.e. increase the floor surface temperature about 2°C!
- Once installation is completed, the heat must be gradually increased by 3°C per day until the desired setting is reached.
- Cable type radiant heating must be covered with a minimum ¼" screed.
- Follow the heating regulation recommendations given by the system supplier. Separate floor areas not having sub floor heating with expansion joints.
- When installing over a radiant heated floor, always use construction adhesive to attach transition pieces.

---

## HARBINGER SIGNATURE ACOUSTIC CLICK INSTALLATION GUIDE

---

### MEASUREMENTS

- Agree with the client on which direction the floor boards should run since this influences the visual size ratio of the space. Installation parallel to the longest wall or with the main light-source is recommended for best visual effects.
- Pre-plan the floor by measuring the room first. If the width of the last row is less than 5 cm (2"), cut the first and the last plank in equal width.
- For larger areas of flooring, expansion gaps should be provided. Place expansion gaps in room narrowing and in the door jambs. Cover the expansion gaps with suitable coverings.
- For larger areas of flooring, areas up to 4,000sf may be installed without transitions except in doorways and areas of significant narrowing i.e. hallways (maximum 100 linear ft in length).

### INSTALLATION METHOD OF FLOOR PLANKS OR TILES

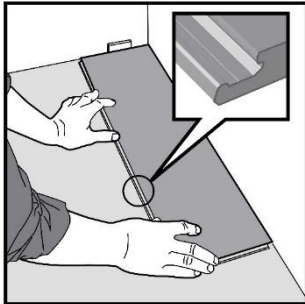

First plank, first row: Place a 5-6 mm thick spacer to the left and position the plank against the wall.

Later, after 3 rows, you can easily position the flooring 5-6mm from the wall and install spacers.

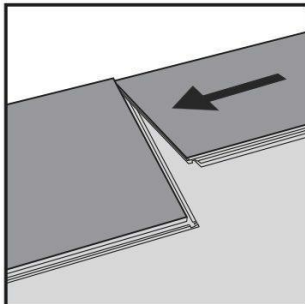

Second plank, first row: Place this plank gently and tight to the short end of the first one.

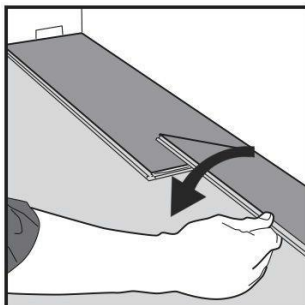

Fold the plank down in a single action movement. During the fold down, make sure the planks are tight against each other. Afterwards press or slightly knock at the short end just installed.

F

---

## HARBINGER SIGNATURE ACOUSTIC CLICK INSTALLATION GUIDE

---

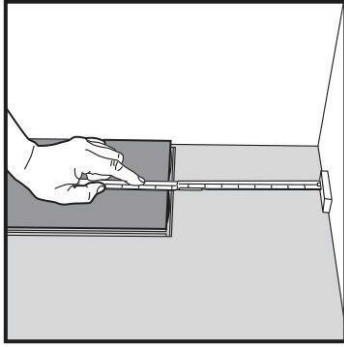

At the end of the first row, put a distance 5-10 mm, to the wall and measure the length of the last plank to be fit

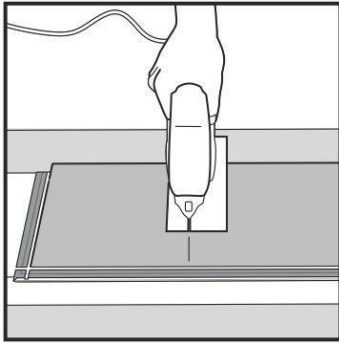

Cut with a jig saw, hand saw, knife or laminate cutter.

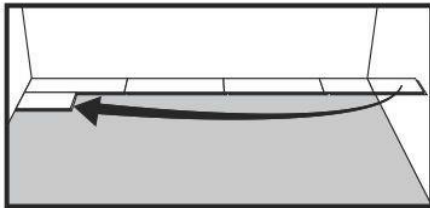

Second Row – Place first plank of minimum length 50cm and put a spacer against the wall.

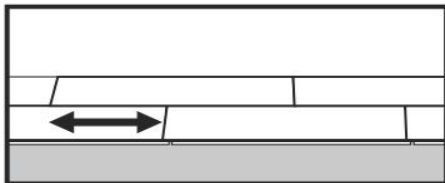

Minimum distance between ends of planks in parallel rows shall not be less than 50 cm.

---

## HARBINGER SIGNATURE ACOUSTIC CLICK INSTALLATION GUIDE

---

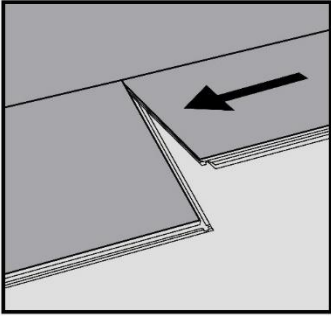

Second plank, second row.  
Place the plank **gently and tight** to the short end of the previous plank.

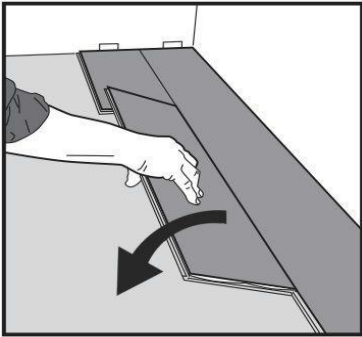

Fold the plank down in a single action movement with a slight press to the left to the short end of the previous plank. During the fold down, make sure the planks are tight against each other.

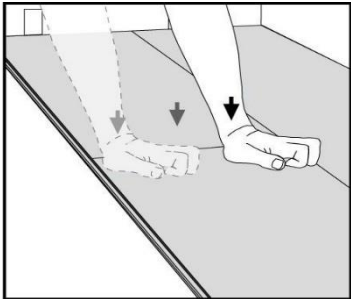

Press or knock slightly along the short end of the installed plank until a click is heard. Do not force or use mallet on seam.

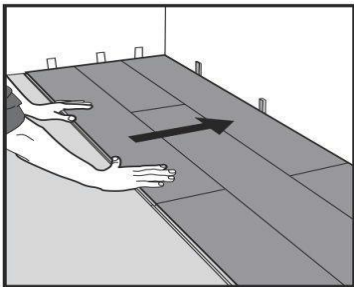

After 2-3 rows.  
Adjust the distance to the wall by pulling floor out and placing spacers of 5-6 mm against wall.

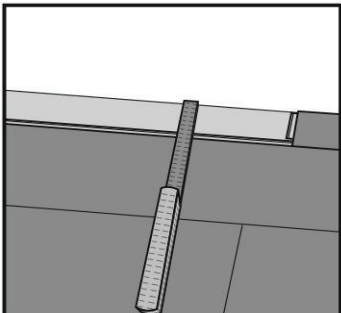

Last row (and perhaps also first row).  
Minimum plank width should be at least 5 cm. Remember to allow for a gap of 5-6 mm to wall. **Tip!** Put a spacer before measuring Cut the plank lengthwise and glue the short ends.

---

## HARBINGER SIGNATURE ACOUSTIC CLICK INSTALLATION GUIDE

---

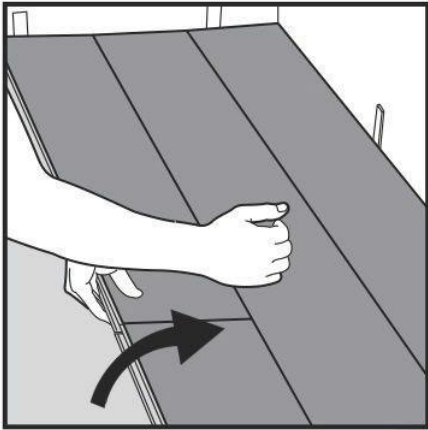

### DISASSEMBLY WITHOUT TOOL

Your floor can very easy be disassembled, which enables replacement during installation and also once installed.



Separate the whole row by carefully lifting up and slightly knocking just above the joint. Fold up and release the whole long side.

Disassemble the planks by sliding horizontally. **Do not fold up!** Lifting will damage end profiles.

### RADIATOR PIPES

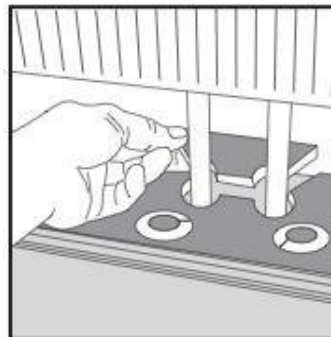
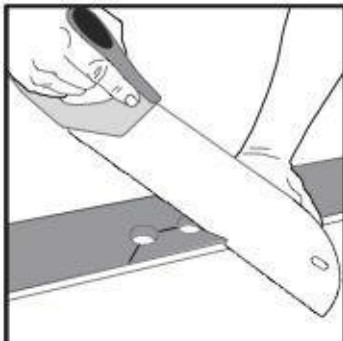

---

## **HARBINGER SIGNATURE ACOUSTIC CLICK INSTALLATION GUIDE**

---

Installation at radiators. Drill the holes 20 mm larger than the diameter of the pipes.

---

## HARBINGER SIGNATURE ACOUSTIC CLICK INSTALLATION GUIDE

---

### SPECIAL INSTALLATIONS

- When installing last row where angle fit is not possible, cut the tongue at the same time you cut the length of the plank and install as shown below.
- Note that the smallest width of a plank is 5cm at the last row – if not - first row must be adjusted. This can easily be calculated when measuring the room width before installation! Cut off the locking element with a chisel, push the planks horizontally together and glue planks together with vinyl seam sealer.
- If necessary, place some spacers between the last plank and the wall to keep the planks together during the curing time of the glue

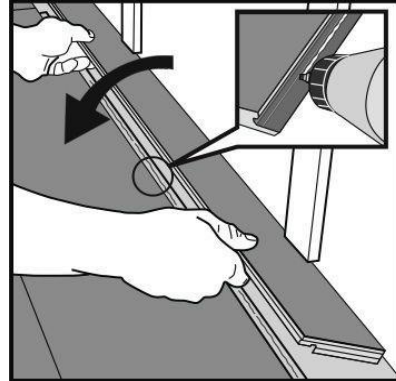
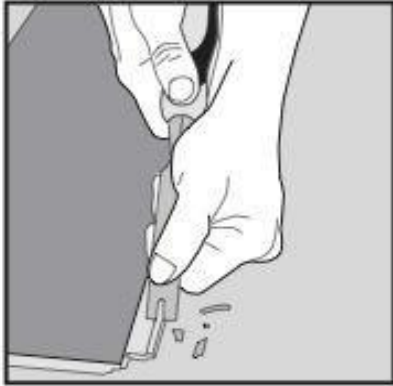

---

## HARBINGER SIGNATURE ACOUSTIC CLICK INSTALLATION GUIDE

---

### CARE & MAINTENANCE

The cleaning and care of floors must be seen as two different things. Whereas cleaning serves the removal of dirt, the aim of care is to improve the surface or restore it to its original quality. The quality of Signature Acoustic Click planks or tiles means that while no care is required, cleaning is. Consequently, no treatment of the flooring before it is first used is necessary. The laid floor must be delivered clean as stipulated (first cleaning after installation) and these care instructions given to the customer.

In the event that additional care products are applied, only those expressly recommended for Harbinger flooring should be used. For routine cleaning, make sure that only suitable cleaning agents (neutral cleaners) are used. For heavy soiling or greasy floors, conventional mild cleaning agents such as those used for routine cleaning may not be suitable because they do not completely remove the soiled or damaged layers. Please contact your Harbinger representative for specific recommendations.

### Precautions

The use of area rugs or mats that effectively remove dirt should be used at all entries, protecting the floor from soiling and abrasion caused by sand, grit and other abrasive particles carried in on shoes.

### First cleaning after installation

Once the floor has been fully laid, clean the surface with water and a neutral cleaner. Cleaning agents with no added care products have proved especially effective. Never use aggressive cleaning agents or solvents (e.g. bathroom detergents).

### Routine cleaning and care

To remove loose particles of dirt, a broom or vacuum cleaner is sufficient. Clinging dirt should be removed with damp mop (not wet) using water and Millennium Neutral Blue Cleaner. Any parts of the floor exhibiting stubborn soiling should be treated separately before cleaning.

### For heavy soiling or greasy floors

Conventional mild cleaning agents such as those used for routine cleaning may not be suitable because they do not completely remove the soil, grease or built-up layers. Please contact your Harbinger representative for specific recommendations.

### GENERAL NOTES

- Place protective pads or floor protectors of the appropriate size to protect parts of the floor on which furniture stands.
- Chemicals of all kinds, such as solvents, medicines and disinfectants, hair dyes, tar, fat, grease, or felt-tip pen ink etc. can permanently discolor the flooring.
- Direct contact between the floor surface and dyed rubber objects such as dirt-trapping mats or rubber protectors on appliances, chair and table legs can permanently discolor the flooring. Any such points of contact should therefore be protected.
- Smoldering cigarette ends cause permanent damage to the flooring.
- Direct sunlight and intense artificial lighting can cause all floor coverings to fade.
- To ensure that the flooring is not damaged or does not lose its sheen where office chairs are used, mats should be laid. A suitable material for such mats is polycarbonate.
- The recommendations of the manufacturer of the cleaning agent used must be strictly observed. Only mild cleaning agents, as explained in "First cleaning after installation", are permissible.

Refer to [www.harbingerfloors.com](http://www.harbingerfloors.com) for cleaning, maintenance, and warranty guidelines.

**WARRANTY CLAIMS MUST BE MADE TO HARBINGER NORTH AMERICA  
TOLL FREE PHONE/FAX 1-866-646-6519**